



## SETUP & OPERATION MANUAL MODEL: 90.700 SCROLL BAND SAW

### FEATURES

The Pégas® SCROLL BAND SAW is a precision machine using Pégas® Scroll Bandsaw blades, the finest and the most accurate blades ever produced. This unique and innovative concept is intended for informed users, from hobbyists to skilled professionals.

- Cast-iron frame for higher longevity and stability
- Balanced aluminum wheels to avoid vibrations, with replaceable rubber tires.
- Two cutting speeds for excellent results in hard and soft woods.
- Top and bottom precision guiding system Pégas® with ball bearings.
- Blade protection guard.
- Led lamp.
- Cast-iron table, with 40° tilting capability, coated with wear-proof and release coating.
- One extra 5mm table insert for table tilting 25° to 40°.
- Dust collection port ideally placed under the worktable.
- Sturdy and easy assembling open steel stand height 580mm and optional stand height 300mm.
- Certified CE by TÜV Rheinland.

### SPECIFICATIONS

WHEEL SIZE: 353 mm (13- 7/8 ")

MAXIMUM BLADE WIDTH: 3mm

MINIMUM BLADE WIDTH: 1mm

BLADE LENGTH : 2375 mm (93 1/2" )

BLADE SPEEDS (2): 700 / 1050 MPM

(1050 MPM is recommended speed for the best scrolling result)

TABLE SIZE : 406 x 406 mm (16" x 16" )

TABLE TILT : 0 - 40°

DUST COLLECTION PORT : 63 mm (2- 1/2")

POWER: 500W 110-120V~, 50Hz, 3/4HP

NET WEIGHT: 77 Kg

LIMITS ON SIZE OF WORK PIECE: 406mm x 406mm x 152mm

(Recommended)



Scies Miniatures Sàrl  
Z.I. Les Plans-Praz  
1337 VALLORBE  
SWITZERLAND  
Email: [pegas@scies.ch](mailto:pegas@scies.ch)

Original instruction Version 01 2016

## INTRODUCTION

Thank you for purchasing model 90.700 scroll band saw, this machine has been carefully tested and inspected before shipment and if properly used and maintained, will provide you with years of reliable service.

### VERY IMPORTANT

**It is new concept, which you maybe still never seen. We strongly recommend to read carefully and completely this manual; especially the setting up and the fine-tuning of the blade. A bad adjustment of guides and blade will make this new concept totally ineffective and cause a premature wear of elements in movements.**

### WARRANTY

All components parts of scroll band saw are carefully tested and inspected during all stages of production, and each unit is thoroughly inspected upon completion of assembly.

Within a period of 2 years from date of purchase, any genuine parts or parts which, upon examination, prove to be defective in workmanship or material are guarantee to repair or replace.

Along with the return of the product being claimed for warranty, a copy of the original proof of purchase, clearly stating the model and serial number of the unit and including an explanation of the complaint or presumed defect in material or workmanship.



**WARNING** When using electric tools basic safety precautions should always be followed to reduce the risk of fire, electric shock and personal injury including the following.

Read all these instructions before attempting to operate this product and save these instructions.

**Generally, the scroll band saw shall be installed in the following conditions:**

- 1) Supply voltage: 220-240 VAC
- 2) Source frequency: 50 HZ
- 3) Ambient temperature: 5°C - 40°C.
- 4) Relative humidity: not exceed 50% at 40°C.
- 5) Atmosphere: Free from excessive dust, acid fume, corrosive gases and salt.
- 6) Avoid exposing to direct sunlight or heat rays which can change the environmental temp.
- 7) Avoid exposing to abnormal vibration.
- 8) Electrical equipment shall withstand the effects of transportation and storage temperature within a range of -25°C to 55°C and for short periods not exceeding 24 hours at up to +70°C.

### SAFETY RULES

- 1 - Keep work area clear
  - Cluttered areas and benches invite injuries.
- 2 - Consider work area environment
  - Do not expose tools to rain.
  - Do not use tools in damp or wet locations.
  - Keep work area well lit.
  - Do not use tools in the presence of flammable liquids or gases.
- 3 - Guard against electric shock
  - Avoid body contact with earthed or grounded surfaces
- 4 - Keep other persons away

- Do not let persons, especially children, not involved in the work touch the tool or the extension cord and keep them away from the work area.
- 5 - Store idle tools
    - When not in use, tools should be stored in a dry locked-up place, out of reach of children.
  - 6 - Do not force the tool
    - It will do the job better and safer at the rate for which it was intended.
  - 7 - Use the right tool
    - Do not force small tools to do the job of a heavy duty tool.
    - Do not use tools for purposes not intended; for example do not use band saws to cut Food or combustibles.
  - 8 - Dress properly
    - Do not wear loose clothing or jewellery, they can be caught in moving parts.
    - Non-skid footwear is recommended when working outdoors.
    - Wear protective hair covering to contain long hair.
  - 9 - Use protective equipment
    - Use safety glasses.
    - Use face or dust mask.
    - Use ear protect.
    - Use safety gloves.
  - 10 - Connect dust extraction equipment
    - tool is provided for the connection of dust extraction and collecting equipment, ensure these are connected and properly used.
  - 11 - Do not abuse the cord
    - Never yank the cord to disconnect it from the socket. Keep the cord away from heat, oil and sharp edges.
  - 12 - Secure work
    - Where possible use clamps or a vice to hold the work. It is safer than using your hand.
  - 13 - Do not overreach
    - Keep proper footing and balance at all times.
  - 14 - Maintain tools with care
    - Keep cutting tools sharp and clean for better and safer performance.
    - Follow instruction for lubricating and changing accessories.
    - Inspect tool cords periodically and if damaged have them repaired by an authorized service facility.
    - Inspect extension cords periodically and replace if damaged.
    - Keep handles dry, clean and free from oil and grease.
  - 15 - Disconnect tools
    - When not in use, before servicing and when changing accessories such as blade, disconnect tools from the power supply.
  - 16 - Remove adjusting keys and wrenches
    - Form the habit of checking to see that keys and adjusting wrenches are removed from the tool before turning it on.
  - 17 - Avoid unintentional starting
    - Ensure switch is in "off" position when plugging in.
  - 18 - Use outdoor extension leads
    - When the tool is used outdoors, use only extension cords intended for outdoor use and so marked.
  - 19 - Stay alert
    - Watch what you are doing, use common sense and do not operate the tool when you are tired.
  - 20 - Check damaged parts

- Before further use of tool, it should be carefully checked to determine that it will operate properly and perform its intended function.
- Check for alignment of moving parts, binding of moving parts, breakage of parts, mounting and any other conditions that may affect its operation.
- A guard or other part that is damaged should be properly repaired or replaced by an authorized service centre unless otherwise indicated in this instruction manual.
- Have defective switches replaced by an authorized service centre.
- Do not use the tool if the switch does not turn it on and off.

21 - Warning

- The use of any accessory or attachment other than one recommended in this instruction manual may present a risk of personal injury.

22 - Have your tool repaired by a qualified person

- This electric tool complies with the relevant safety rules. Repairs should only be carried out by qualified persons using original spare parts, otherwise this may result in considerable danger to the user.

The figures quoted are emission levels and are not necessarily safe working levels. Whilst there is a correlation between the emission and exposure levels, this cannot be used reliably to determine whether or not further precautions are required. Factors that influence the actual level of exposure of the workforce include the characteristics of the work room and the other sources of noise, etc., i.e. the number of machines and other adjacent processes. Also the permissible exposure level can vary from country to country. This information, however, will enable the user of the machine to make a better evaluation of the hazard and risk.

**Test under no load**

A-weighted sound power level

**L<sub>WA</sub> = 78 dB                  Uncertainty K<sub>WA</sub> = 4 dB**

**Test under load**

A-weighted sound power level

**L<sub>WA</sub> = 90 dB                  Uncertainty K<sub>WA</sub> = 4 dB**



**WARNING** The symbols below advise that you follow the correct safety procedures when using this machine.



Keep away your fingers from the saw blade



Keep away your fingers from the blade wheel



Dust mask should be worn



Disconnect from power supply before servicing



Eye protection should be worn



Fully read manual and safety instructions before use



Ear protection should be worn



Safety gloves should be worn



## EC DECLARATION OF CONFORMITY

**We Scies Miniatures Sàrl**

**Z.I. Les Plans-Praz 1337 VALLORBE SWITZERLAND**

declare in sole responsibility that the equipment

Equipment : Band saw (Scroll band saw)

Model/ serial no.: 90.700

to which this declaration applies, complies with these normative documents:

- Machinery Directive: 2006/42/EC

and conforms to the following EN standard,

- EN ISO 1807-1: 2013
- EN 60204-1: 2006+A1: 2009
- Low Voltage Directive: 2014/35/EU
- EMC Directive: 2014/30/EU

Authorized representative established within the EU

Company Name : Scies Miniatures Sàrl

Company Address : Z.I. Les Plans-Praz 1337 VALLORBE SWITZERLAND

Person responsible for compiling the technical file established within the EU

Name, Surname : Roger Favre

Address : Z.I. Les Plans-Praz 1337 VALLORBE SWITZERLAND

This declaration is based on:

Third party testing, performed by the Notified Body TÜV Rheinland LGA Products GmbH

TÜV Rheinland Certificate Nr.: BM 50330286 0001



Year of affixing CE marking: 2016

Signature

Name, Surname: : Roger Favre  
Position/ Title: : Managing Director  
Date : 29.08.2017

## TRANSPORTING AND HANDLING

This machine shall be moved by persons who are qualified. Persons besides the worker are not allowed to stay in the work place during transporting the machine. Plate trailer can be used in handling, make sure that machine is loaded vertically and the strength of plate trailer is sufficient to hand the machine. Transport the machine with the band guard fully down and close to the table.



## UNPACKING

Carefully unpack and remove the unit and its components from its shipping container and check for missing or damaged items as the list of contents below.



**WARNING:** Due to the fact that saw blade is fine and precise, pay attention do not to damage the saw blades during transport and the manipulation of the machine.

## CONTENT LIST

- Scroll band saw with one blade #12 (mounted) x 1
- Blade #9 x 1
- Table x 1
- Table insert 5mm x 1
- Dust port x1 + Screw and Washer x 2
- Table tilt bracket x 1
- Lock knob x 2
- Allen key x 1
- Long Hex head bolt w/Hex nut x 1
- Medium Hex head bolt w/flat washer x 2



## PLACEMENT WITHIN THE SHOP

This machine should be installed and operated only on a solid, flat and stable floor, that is able to support the weight of the saw 81kg and the operator. Minimum space recommended for placement within your shop that will allow the operator to work comfortably and in a safe place is 80cm x 70cm.

(Plus the space for the operator.)

## ASSEMBLY INSTRUCTIONS



**WARNING** Do not connect the machine while it is not fully installed.

### ASSEMBLING THE STAND

- Follow the instructions on both annexed sheets.

### ASSEMBLING THE BAND SAW TO THE STAND

- Lift the saw body with help of an assistant, place the band saw on the stand and maintain it firmly.
- Place both reinforcing ribs under the top plate, use 4 long hex heads passing through reinforcing ribs and top plate, 8 flat washers and 4 hex nuts.
- Secure the saw by tightening all mounting bolts of the stand.



### ASSEMBLING THE DUST PORT

1. The dust port has a 63.5mm (2 -1/2") opening to accommodate connection to a dust collector (not included).
2. Open the lower cover door and Install the dust outlet on the right side of the saw

**⚠️ WARNING** Do not connect the machine while it is not fully installed.

**ASSEMBLING BLADE & ADJUSTING BLADE TENSION AND TRACKING**

When the machine is correctly fixed on the stand, take care of these very important information, which will be followed systematically also when you install a new blade or when you change the size of the blade.

- Look at both upper and lower precision guiding systems ball bearings and get used with this new system.
- Turn slowly the wheel by hand and see the position of the blade, more or less at the center of the rubber tires, and into the grooves of the ball bearings. (image A)

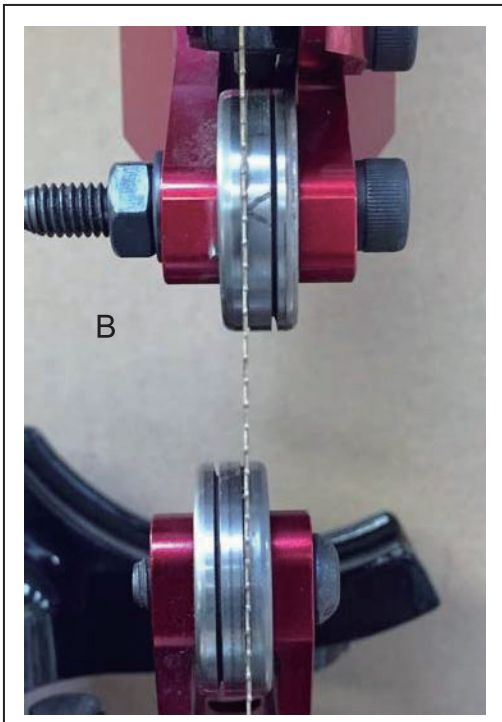
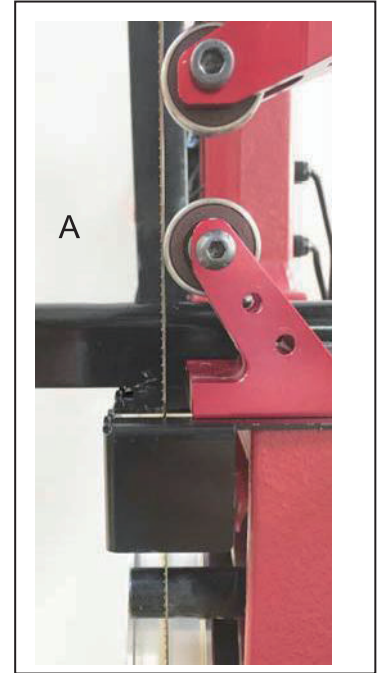

**⚠️ WARNING**

Notice that the blade is into the left groove at the upper ball bearing and the right groove at the lower ball bearing.

**IT'S NORMAL AND NECESSARY.** (image B)

- The back of the blade should touch the bottom of the grooves and just entails **slightly** the rotation of the ball bearings. (image C)
- In order to check the right adjustment of the guides, made in factory, unblock both Allen screws fixing upper and lower ball bearings. (image D)

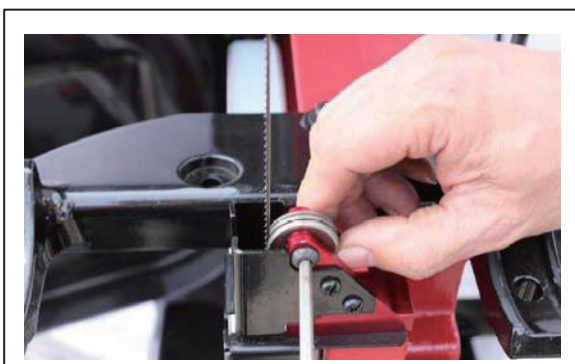
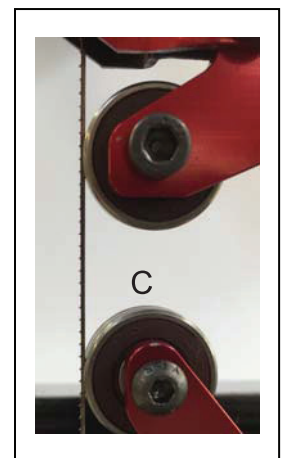

D

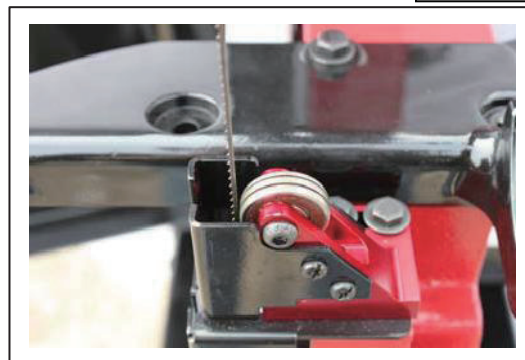

- Notice that there is an important radial clearance and the ball bearings can be moved of about 3mm. **IT'S NORMAL AND NECESSARY TO INSURE A FINE AND PRECISE ADJUSTMENT.** (Image D)
- Push both ball bearings in the most back position and block them in this position by tightening slightly the Allen screws by hand. **Now the blade should be outside the grooves.**
- Turn again slowly the upper wheel by hand: the blade must keep its position at the center of the rubber tires.
- If the blade leaves its initial position on the rubber tire more than 3mm, you have to adjust the blade tracking with the lateral knob at the back of the machine. (image E)
- When you have finished adjusting the blade tracking, block the locknut on the lateral knob. Normally you should not have to adjust the blade tracking all the time.
- Then, **beginning with lower guide**, unblock the Allen screw and move the ball bearing forward until bottom of the grooves just touch slightly the back of the blade. Vertically, the ball bearing must be centered as well as possible.
- At this point, when turning the upper wheel by hand, the ball bearing should rotate slightly.
- Then make exactly the same thing with upper guide.



**⚠ WARNING: Tighten the screws and make sure the ball bearings are turning easily.**

When you have to change the size of the blade don't forget to accord the ball bearing to the blade. You find all the details in the table below. (Fig.1)

**The ball bearing delivered with the machine has two different groove sizes.**

One larger and one narrower. (image G).

The blade mounted on the machine is blade number #12 and according to what is wrote above, the blade is into the left groove (larger) on the upper guide, and right groove (larger too!) on the lower guide. (image F)

With the machine, you also receive a free blade number #9.

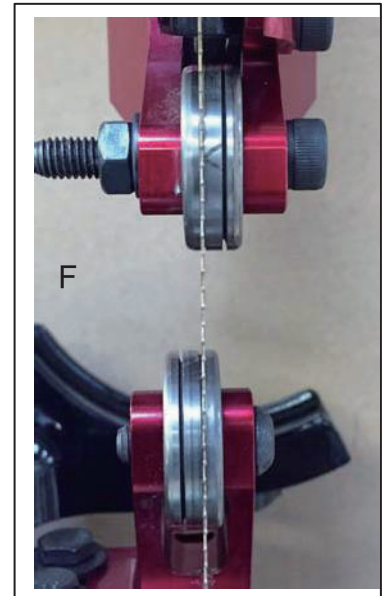

When you want to use it, you MUST turn both ball bearings in order to use the narrower grooves.



**Optional ball bearings**

All other sizes of blades and ball bearings are available on request from our retailers.

For a precise work, we recommend to use the ball bearing corresponding to the blade

n°	Art.	 		Z/cm	TPI	Appropriate Ball Bearing
		[mm]	[mm]			
5	91.005/2375	0,36	1,02	5,3	13,4	92.000-5
7	91.007/2375	0,40	1,24	4,6	11,8	92.000-7/9
9	91.009/2375	0,44	1,34	4,1	10,5	92.000-7/9
11	91.011/2375	0,50	1,80	3,6	9,2	92.000-11/12
12	91.012/2375	0,50	2,00	3,5	8,9	92.000-11/12
14	91.014/2375	0,50	3,00	3,2	8,2	92.000-14

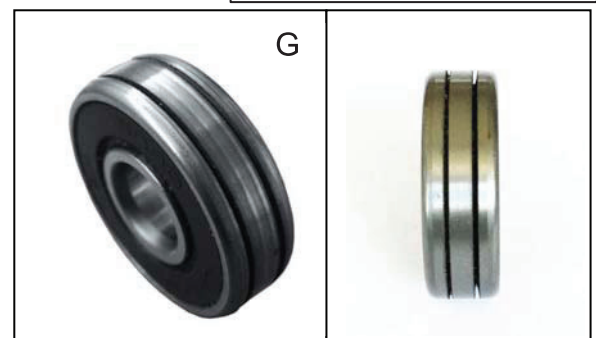

Fig.1

## ASSEMBLING THE TABLE

Now you are ready to go to the next step, assembling the table.

If you are alone we recommend firstly to remove the blade from the band saw before installing the table to avoid breaking the fine blade. If somebody is helping you, (we recommend it, you should be able to install the table without any damage to the blade.

Directions:

1. Install the table-tilting bracket with two hex head bolt with flat washer. Block the bolts A (image H)

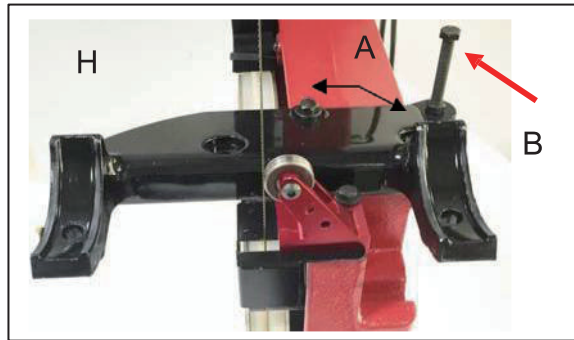

2. Put in place the long hex head bolt B with nut. (image H). Don't block it now. This bolt is the stop block where the table will lean on when the table will be perfectly square.
3. Remove the insert from the center of the table and the table alignment pin on the side of the table. (image I)
4. This insert rests on four Allen screws. Screw/unscrew these four screws to adjust the position of this insert on the surface of the table. (image J)

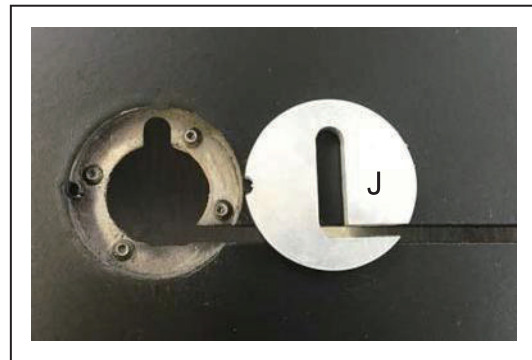
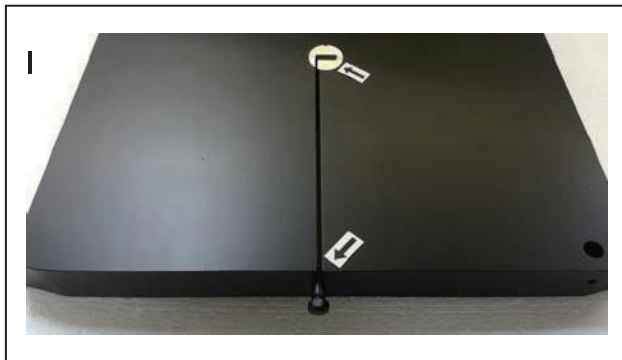

5. Grab the table on hand and turn it with the black face on top. Under the table verify that the long bolts are hanging at the center of each trunnion. If the blade is still on the machine, move the table very carefully, the blade passing through the slot until the blade is at the central part of the table. Then take it down at his final position, both long bolts passing through the table-tilting bracket. Finally put in place both lock knobs. (image K-L-M).

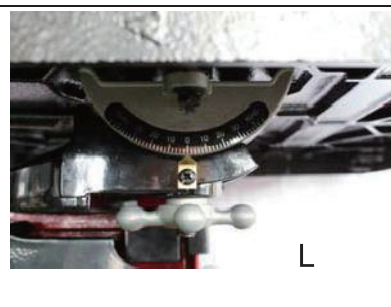
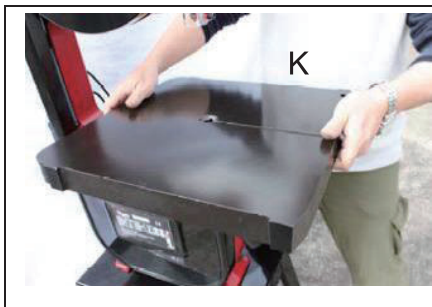

6. If you have removed the blade, you have now to put it back, following the instructions concerning this important point. (Pages 7+8).



7. Re-install the table insert in the center of table and the alignment pin on the side. (Images N + O)

### 8. Adjusting blade tension

Determining ideal blade tension is somewhat subjective. It is learned through practice and experience, depending of personal preference and individual work habits.

But you need to know that the best work will be always made with a blade rather too tense than not enough.

#### **Suggestion:**

When the blade is in tension and the upper guide in highest position, push the blade at middle height with your finger, if you are able to obtain an arrow of 3-4mm, the tension is correct. (Image P)

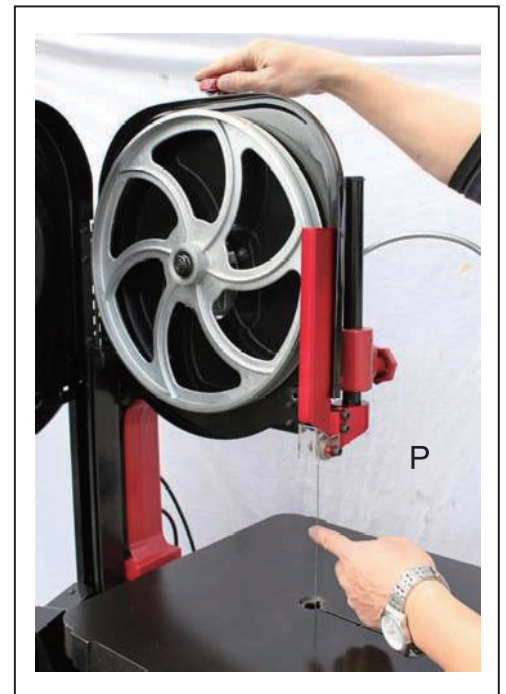

## **BASIC ADJUSTMENTS AND CONTROLS**

Very important: verification of the squaring between the table and the blade.

1. Screw the screw B (image H page 9) of about 10mm, the head of the bolt must not be in contact with the table.
2. Unscrew both lock knobs then adjust perfectly the angle with a square gauge, block again the table. (image Q)
3. Unscrew the screw B until it just touch the table, block the nut. The stop block is now in place and the 90° angle will be easily found again in the future.

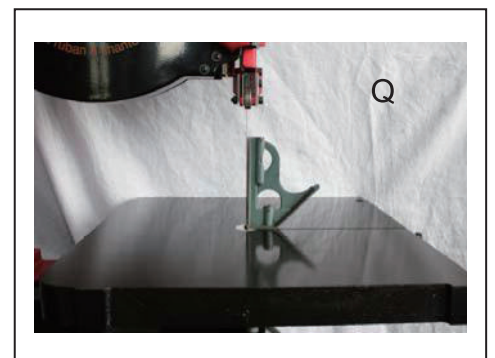



To avoid unexpected or unintentional start-up, make sure that the power switch is in the OFF before connecting to a power source. Do not try to use the machine unless all the guards and other safety devices necessary for machining are in good working order.

### ADJUSTING THE UPPER GUARD

1. Turn off the saw and disconnect the power source.
2. Loosen the lock knob **A**.
3. Move the upper guide **B** assembly up or down and re-tighten the lock knob **A**.

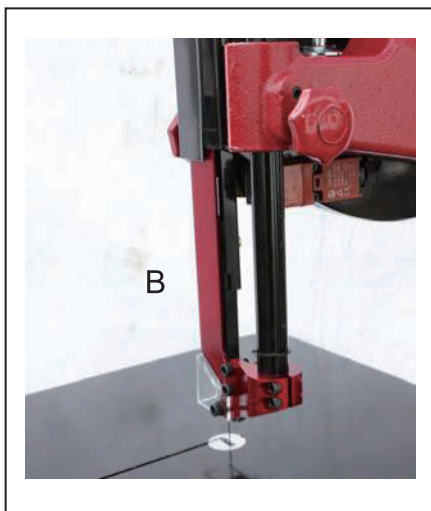

**IMPORTANT POINT:** For best sawing results, the upper ball bearing needs to be adjusted as close as possible to the piece to cut.

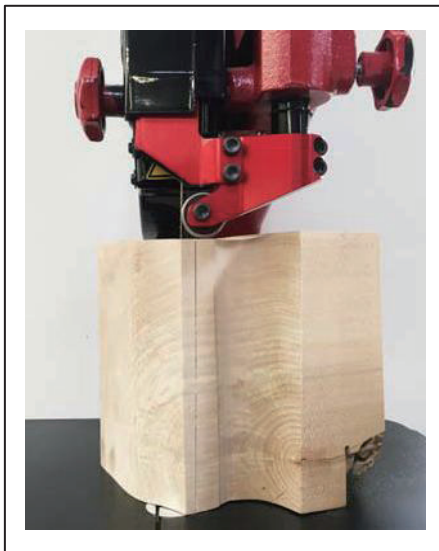

## POWER ON/OFF SWITCH

Plug the power cable into a correctly rated switch socket outlet. If extension leads are being used, check these and make sure that they are not damaged.

**This scroll band saw is equipped with a magnetic ON/OFF switch (A)**

To START the saw: Press the green button "I".

To STOP the saw: Press the red button "O".

Whenever the saw is not in use, insure the saw is switch OFF by pressing the red button "O"

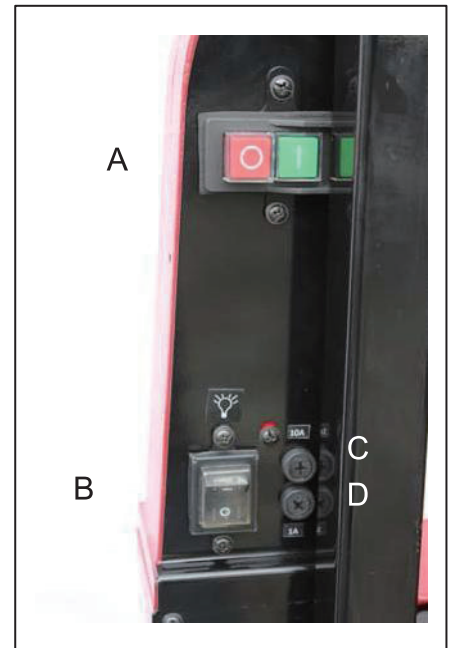

## LED work light

High quality LED work light is installed on saw itself.

LED ON/OFF switch B is on the arm with light mark.

## Fuse

This saw takes 2 fuses.

Fuse C 10 AMP for protecting machine electricity.

Fuse D 1 AMP for protecting LED light.

## Protection

When this saw is pressed OFF from the power, the saw blade and wheels will stop running within 10 seconds to avoid any accidental injury from the running parts.

(CE regulation)



## SAFETY DEVICES

The saw is equipped with a safety switch system, which quickly interrupts the machine if the doors are opened during operation. The machine will restart when the doors are in closed position and the green button pressed again.



**WARNING: the pin of breaker is exposed, pay attention in the pin to avoid injury.**



**Warning that in case of loss of power supply, the braking function is not operating, and it is necessary to wait for the complete standstill of the machine before opening the doors. In case of broken band or belt if fitted, the wheels may keep running, and it is necessary to wait for the complete standstill of the machine before opening the doors.**

## CHANGING SPEED SETTINGS

This machine has 2 different speed settings: 700 MPM /1050 MPM

To change the speed setting:

1. Turn off power and disconnect the saw from the power source.
2. Open the door.
3. At the back of the saw, just above the motor, there is a ratchet lever to loosen the drive belt, unscrew the bolt a few turns - counterclockwise then pull up on the capacitor cover of the motor and pivot the motor to the left. This loosens the belt enough to move it between one set of pulleys and the other.
4. 700MPM, place the belt on the front most set of pulleys as left drawing.
5. 1050MPM, place the belt on the rearmost set of pulleys as right drawing.
6. Having repositioned the belt, push down firmly on the motor capacitor cover to tighten the belt, turn the ratchet lever clockwise until it is tight and the motor does not move.

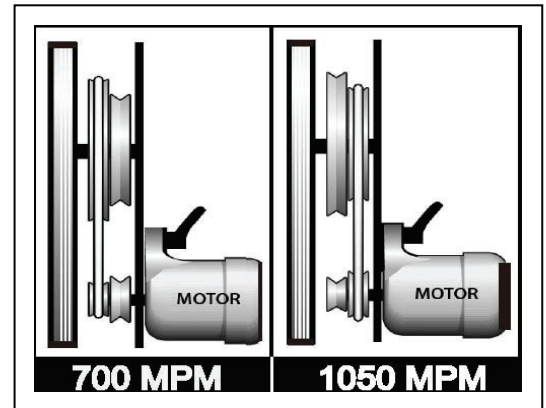
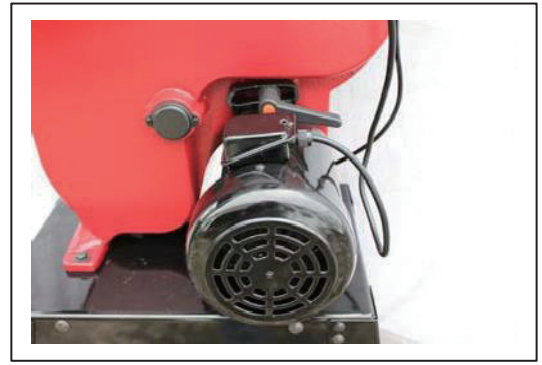

## REQUIRED MAINTENANCE

Wheel tires can be replaced if they get worn out or broken.

If it is worn out, the blade will not track straight on the wheels.

To remove the tire from the wheel groove use a flat screwdriver and install the new tire.



**Do not glue the tire on the wheels.**

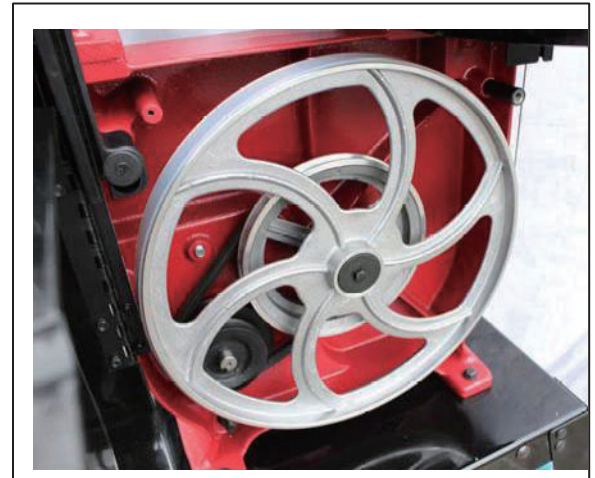

## ADJUSTING/REPLACING THE LOWER WHEEL BRUSH

Verify the brush keeps the lower wheel surface clean at all times, if pitch and sawdust builds up on the lower tire, adjust or change the brush with use and normal wear over time, the brush hairs will soften and will not clear the wheel surface as well, lower the brush or change the slightly.

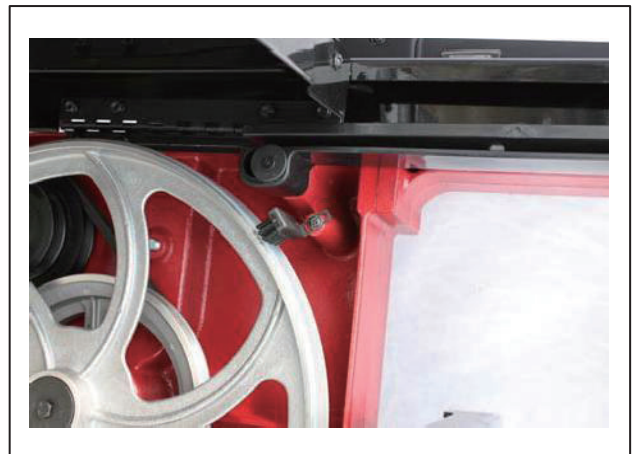

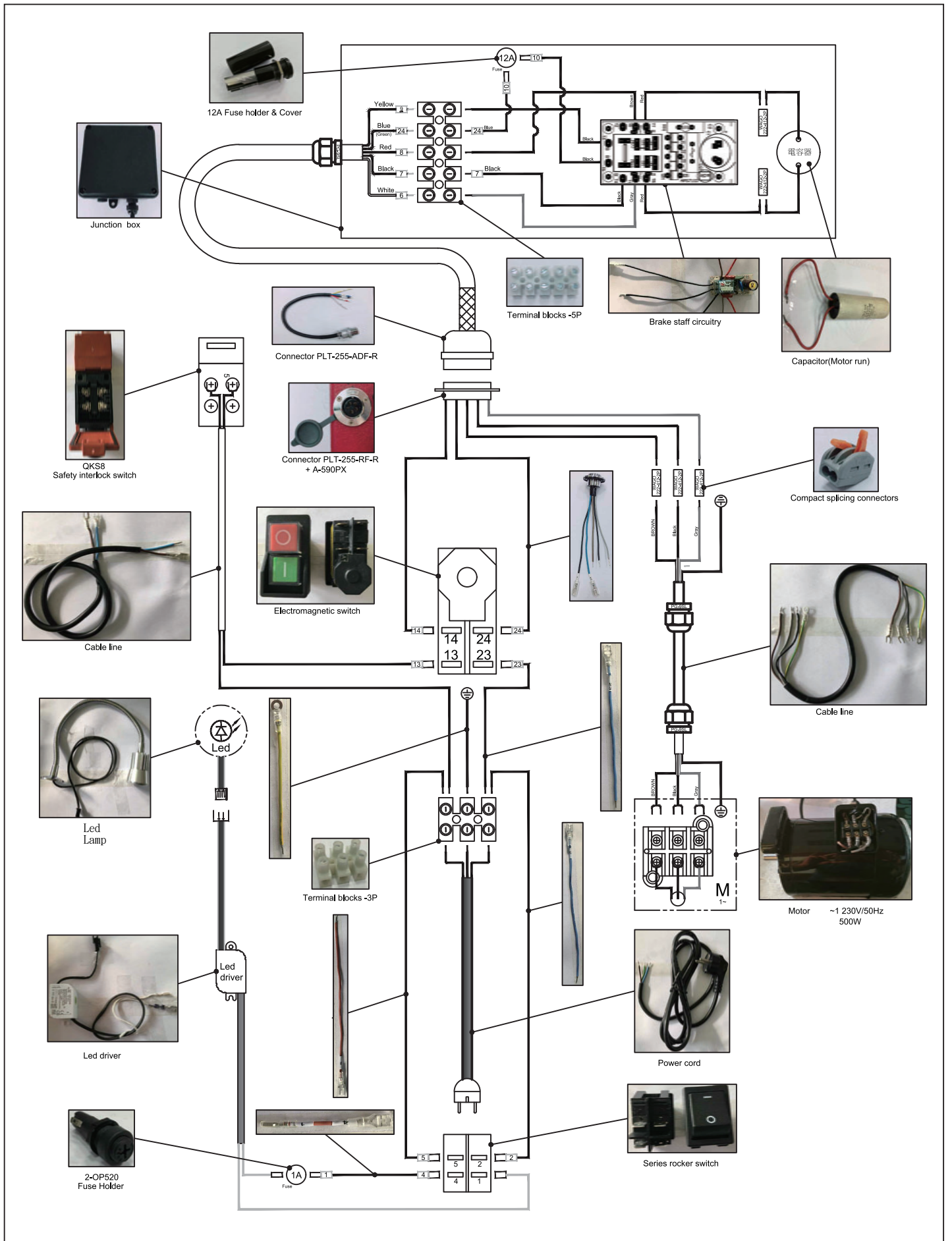

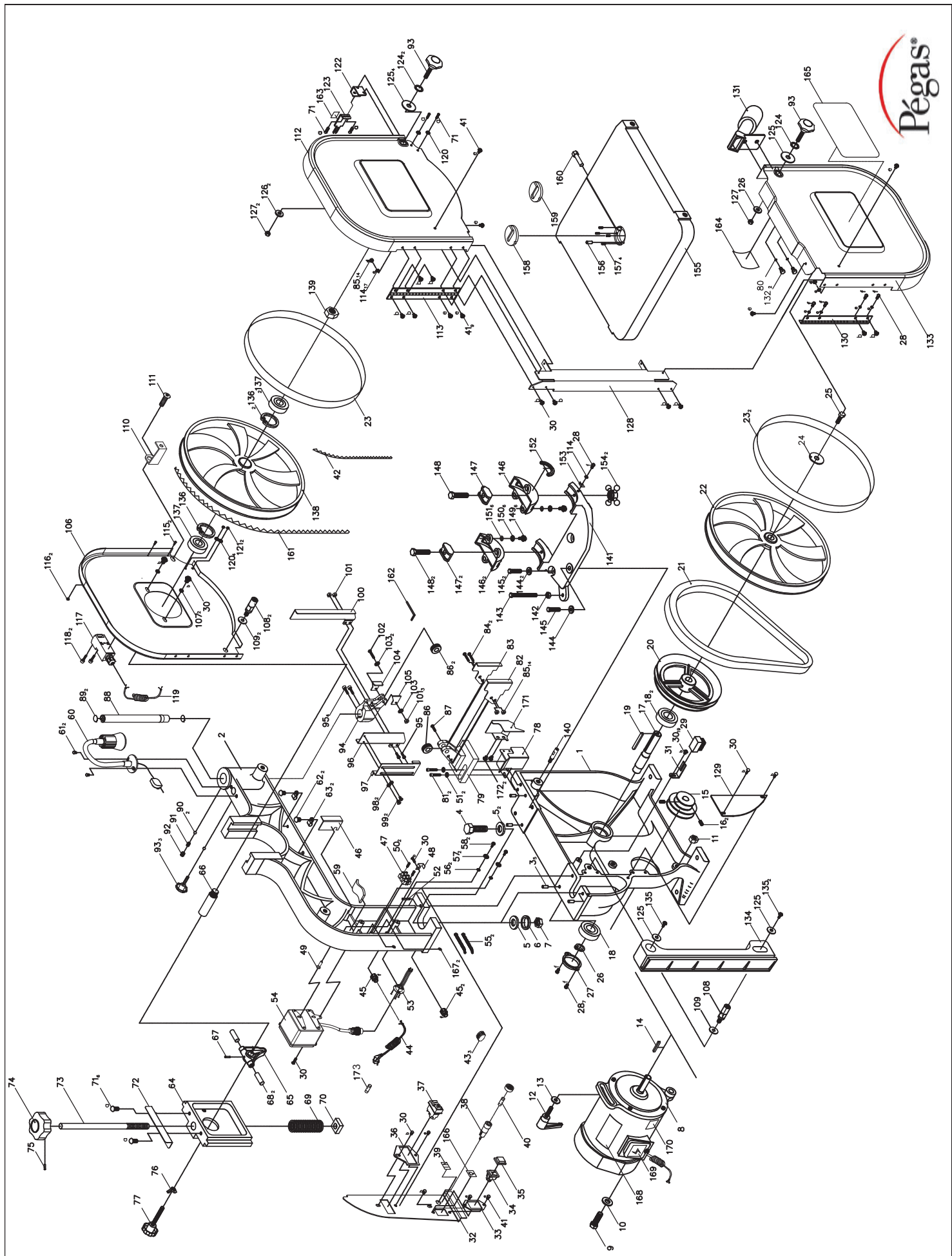

PARTS LIST  
SRP14-CE

PARTS NO.	DESCRIPTION	SPEC.	QTY
SRP14CE-01	Base		1
SRP14CE-02	Upper Frame		1
SRP14CE-03	Steel Pin	1/4"x16mm	5
SRP14CE-04	Hex Screw	3/4"x2-1/2"	1
SRP14CE-05	Flat Washer	3/4"	2
SRP14CE-06	Spring Washer	3/4"	1
SRP14CE-07	Hex Nut	3/4"	1
SRP14CE-08	Motor		1
SRP14CE-09	Hex Screw	1/2"x2-1/2"	1
SRP14CE-10	Flat Washer	1/2"	1
SRP14CE-11	Nylon Nut	1/2"	1
SRP14CE-12	Knob	3/8"x45L	1
SRP14CE-13	Flat Washer	3/8"	1
SRP14CE-14	Key	5x5x35L	1
SRP14CE-15	Motor Pulley		1
SRP14CE-16	Set Screw	M6x14L	2
SRP14CE-17	Lower Shaft		1
SRP14CE-18	Ball Bearing	6204LLB	2
SRP14CE-19	Key	5x5x60L	1
SRP14CE-20	Pulley	7"	1
SRP14CE-21	V Belt	A-27	1
SRP14CE-22	Lower Wheel		1
SRP14CE-23	Tire		2
SRP14CE-24	Flat Washer	1/4"	1
SRP14CE-25	Hex Screw	1/4"x5/8"	1
SRP14CE-26	C-Ring	S-20	1
SRP14CE-27	Bearing Cover		1
SRP14CE-28	Cross Hd Screw	3/16"x3/8"	7
SRP14CE-29	Brush		1
SRP14CE-30	Cross Hd Screw w/Washer	3/16"x3/8"	19
SRP14CE-31	Brush Holder		1
SRP14CE-32	Frame Cover (Upper)		1
SRP14CE-33 & 34 & 35	Switch for LED Light	RF-1004	1
SRP14CE-36 & 37	Switch		1
SRP14CE-38	Fuse Holder		1
SRP14CE-39	Fuse Sticker	1A	1
SRP14CE-40	Fuse	1A	1
SRP14CE-41	Cross Hd Screw w/Washer	3/16"x1/4"	9
SRP14CE-42	Blade	#9	1
SRP14CE-43	Quick Connector	WAGO-222-412-2P	3
SRP14CE-44	Power Cord		1
SRP14CE-45	Strain Relief Bushing	PG-9SL	2
SRP14CE-46	Dust Cover		1
SRP14CE-47	Terminal Block		1
SRP14CE-48	Clip		1
SRP14CE-49	Cross Hd Screw	3/16"x1/4"	1
SRP14CE-50	Cross Hd Screw	M3x15	2
SRP14CE-51	Flat Washer	1/4"	2

PARTS LIST  
SRP14-CE

PARTS NO.	DESCRIPTION	SPEC.	QTY
SRP14CE-52	Spring Pin		1
SRP14CE-53	Aviation Connector Socket		1
SRP14CE-54	Electrical Box		1
SRP14CE-55	Girdle		2
SRP14CE-56	External Gear Washer	M5	2
SRP14CE-57	Copper Washer	M5	2
SRP14CE-58	Cross Hd Screw w/Washer	3/16"x1/4"	2
SRP14CE-59	Foam Sticker		1
SRP14CE-60	LED Light		1
SRP14CE-61	Cross Hd Screw	M3x8	2
SRP14CE-62	Cross Hd Screw	3/16"x5/16"	2
SRP14CE-63	Clip	ACC-2.5	2
SRP14CE-64	Tensioning Cover		1
SRP14CE-65	Tensioning Cam		1
SRP14CE-66	Upper Shaft		1
SRP14CE-67	Spring Pin		1
SRP14CE-68	Fixed Shaft		2
SRP14CE-69	Spring		1
SRP14CE-70	Square Nut	3/8"	1
SRP14CE-71	Cross Hd Screw	M4x5	6
SRP14CE-72	L Type Back Plate		1
SRP14CE-73 & 74 & 75	Blade Tension Adjustment Knob		1
SRP14CE-76	Wing Nut	5/16"	1
SRP14CE-77	Blade Tracking Knob	5/16"x2"	1
SRP14CE-78	Lower Saw Blade Cover Dust Collector		1
SRP14CE-79	Lower Blade Guide Holder		1
SRP14CE-80	Flat Washer	1/4"	2
SRP14CE-81	Hex Screw	1/4"x3/4"	2
SRP14CE-82	Lower Blade Guard ( L )		1
SRP14CE-83	Lower Blade Guard ( R )		1
SRP14CE-84	Cross Hd Screw	3/16"x1"	2
SRP14CE-85	Hex Nut	3/16"	14
SRP14CE-86	Bearing	629RS	2
SRP14CE-87	Hex Screw	M6x18	1
SRP14CE-88	Guide Post		1
SRP14CE-89	C-Ring	S-22	2
SRP14CE-90	Small Steel Ball	1/4"	2
SRP14CE-91	Spring		1
SRP14CE-92	Set Screw	5/16"x5/16"	1
SRP14CE-93	Knob	5/16"x1-1/4"	3
SRP14CE-94	Upper Blade Guide Holder		1
SRP14CE-95	Sleeve Screw	M6x15	4
SRP14CE-96	Upper Blade Guide ( L Lower )		1
SRP14CE-97	Upper Blade Guide ( L Upper )		1
SRP14CE-98	Copper Sets		2
SRP14CE-99	Hex Screw	M4x8	2
SRP14CE-100	Blade Guard ( R )		1
SRP14CE-101	Hex Nut	M6	3

PARTS LIST  
SRP14-CE

PARTS NO.	DESCRIPTION	SPEC.	QTY
SRP14CE-102	Hex Screw	M6x35	1
SRP14CE-103	Flat Washer	M6	2
SRP14CE-104	Protective Glass for Blade ( R )		1
SRP14CE-105	Protective Glass for Blade ( L )		1
SRP14CE-106	Upper Wheel Housing		1
SRP14CE-107	Flat Washer	3/16"	2
SRP14CE-108	Mounting Post	3/8"	2
SRP14CE-109	Flat Washer	3/8"	2
SRP14CE-110	Mounting Post (Upper Wheel R)		1
SRP14CE-111	Hex Screw	3/8"x1"	1
SRP14CE-112	Upper Cover Door		1
SRP14CE-113	Door Hinge		1
SRP14CE-114	Spring Washer	3/16"	17
SRP14CE-115	Sleeve Screw	M3x10	2
SRP14CE-116	Hex Nut	M3	2
SRP14CE-117	Limit Switch	QKS8	1
SRP14CE-118	Sleeve Screw	M4x30	2
SRP14CE-119	Cable line		1
SRP14CE-120	Flat Washer	M4	4
SRP14CE-121	Hex Nut	M4	2
SRP14CE-122	Thicken Plate for Micro Switch		1
SRP14CE-123	Touch Plate for Micro Switch		1
SRP14CE-124	Wave Washer	WW-8	2
SRP14CE-125	Flat Washer	5/16"	4
SRP14CE-126	Flat Washer	5/16"	2
SRP14CE-127	Nylon Nut	5/16"	2
SRP14CE-128	Connect Plate for Door		1
SRP14CE-129	Arm Cover (Lower)		1
SRP14CE-130	Door Hinge (Lower)		1
SRP14CE-131	Dust Outlet		1
SRP14CE-132	Hex Screw	1/4"x1/4"	2
SRP14CE-133	Lower Door		1
SRP14CE-134	Connect Plate for Blade Guard		1
SRP14CE-135	Screw	3/16"x3/8"	2
SRP14CE-136	C-Ring	R34	2
SRP14CE-137	Ball Bearing	6202LLB	2
SRP14CE-138	Upper Wheel		1
SRP14CE-139	Hex Nut	1/2"	1
SRP14CE-140	Mounting Post	3/8"	1
SRP14CE-141	Table-Tilt Bracket		1
SRP14CE-142	Hex Nut	5/16"	1
SRP14CE-143	Hex Screw	5/16"x3"	1
SRP14CE-144	Flat Washer	5/16"	2
SRP14CE-145	Hex Screw	5/16"x1-1/4"	2
SRP14CE-146	Trunnion		2
SRP14CE-147	Trunnion Clamp Shoe		2
SRP14CE-148	Hex Screw	M10x50L	2
SRP14CE-149	Hex Screw	1/4"x5/8"	6

PARTS LIST  
SRP14-CE

PARTS NO.	DESCRIPTION	SPEC.	QTY
SRP14CE-150	Spring Washer	5/16"	6
SRP14CE-151	Flat Washer	1/4"	6
SRP14CE-152	Scale		1
SRP14CE-153	Pointer		1
SRP14CE-154	Star Knob	M10	2
SRP14CE-155	Table		1
SRP14CE-156	Spring Pin	φ3x10L	1
SRP14CE-157	Set Screw	M4x8	4
SRP14CE-158	Table Insert	3mm	1
SRP14CE-159	Table Insert	5mm	1
SRP14CE-160	Table Alignment Pin		1
SRP14CE-161	Blade	#12	1
SRP14CE-162	Allen Key	4mmx70L	1
SRP14CE-163	Crash Label		1
SRP14CE-164	Speed Label		1
SRP14CE-165	I.D. Label		1
SRP14CE-166	Light Sticker		1
SRP14CE-167	Ground Label		2
SRP14CE-168	Motor Nameplate		1
SRP14CE-169	Lightning Label		1
SRP14CE-170	Temperature Rise Label		1
SRP14CE-171	Lower Saw Blade Cover Dust Collector Attachment		1
SRP14CE-172	Cross Hd Screw w/Washer	3/16"x1/2"	2
SRP14CE-173	Fuse	12A	1



# 58CM STAND DIAGRAM

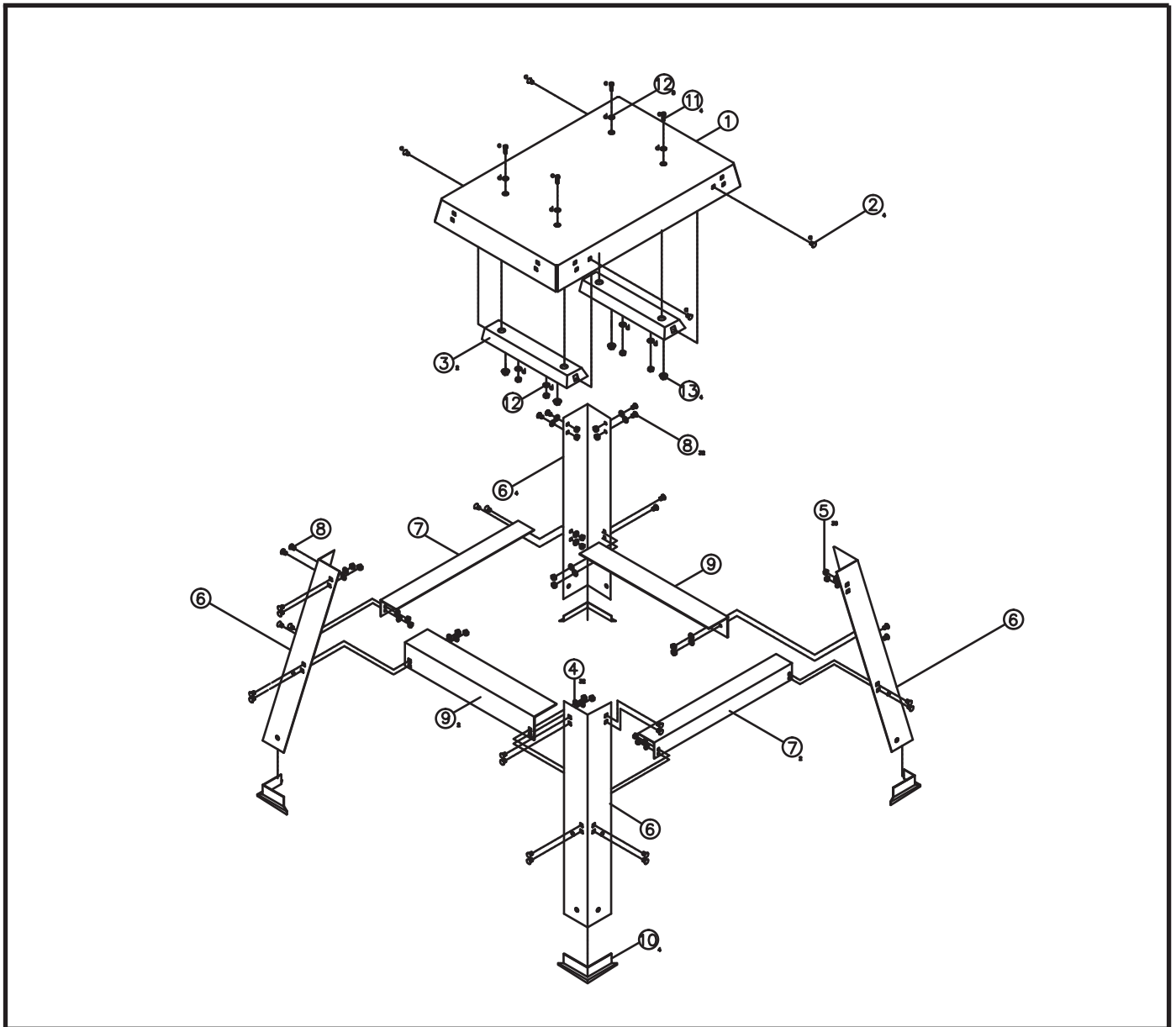

PART NO.	DESCRIPTION	SPECIFICATION	QTY
1	Top Plate		1
2	Carriage Screw	5/16"x3/4"	4
3	Reinforcing Rib		2
4	Flat Washer	5/16"x18x2T	32
5	Hex Nut	5/16"	36
6	Leg		4
7	Lower Bracket (Long)		2
8	Carriage Screw	5/16"x1/2"	32
9	Lower Bracket (Short)		2
10	Foot Pad		4
11	Hex Screw	5/16"x2"	4
12	Flat Washer	5/16"	8
13	Flange Nut	5/16"	4